

Video Doorbell

User's Manual

V1.0.2

Trademark

- VGA is the trademark of IBM.
- Windows logo and Windows are trademarks or registered trademarks of Microsoft.
- Other trademarks and company names mentioned are the properties of their respective owners.

Disclaimer

- Within the scope allowed by applicable laws, in any case, this company won't compensate any special, contingent, indirect and secondary damages resulting from relevant contents and products described in this document, nor compensate any losses in profits, data, reputation, document loss or expected savings.
- Products described in this document are provided "as is". Unless required by applicable laws, this company doesn't provide any express or implicit guarantees for all contents in the document, including but not limited to guarantees for marketability, quality satisfaction, application to specific purpose and non-infringement of third-party rights.

About this Document

- This document is for reference only. Please refer to the actual product for more details.
- This document serves as a reference for multiple types of products, whose specific operations won't be enumerated. Please operate according to actual products.
- The user shall undertake any losses resulting from violation of guidance in the document.
- In case that PDF document cannot be opened, please upgrade the reading tool to the latest version or use other mainstream reading tools.
- This company reserves rights to revise any information in the document anytime; and the revised contents will be added to the new version without prior announcement. Some functions of the products may be slightly different before and after revision.
- The document may include technically inaccurate contents, inconsistencies with product functions and operations, or misprint. Final explanations of the company shall prevail.

Cybersecurity Recommendations

Mandatory actions to be taken towards cybersecurity

1. Change Passwords and Use Strong Passwords:

The number one reason systems get “hacked” is due to having weak or default passwords. It is recommended to change default passwords immediately and choose a strong password whenever possible. A strong password should be made up of at least 8 characters and a combination of special characters, numbers, and upper and lower case letters.

2. Update Firmware

As is standard procedure in the tech-industry, we recommend keeping NVR, DVR, and IP camera firmware up-to-date to ensure the system is current with the latest security patches and fixes.

“Nice to have” recommendations to improve your network security

1. Change Passwords Regularly

Regularly change the credentials to your devices to help ensure that only authorized users are able to access the system.

2. Change Default HTTP and TCP Ports:

- Change default HTTP and TCP ports for systems. These are the two ports used to communicate and to view video feeds remotely.
- These ports can be changed to any set of numbers between 1025-65535. Avoiding the default ports reduces the risk of outsiders being able to guess which ports you are using.

3. Enable HTTPS/SSL:

Set up an SSL Certificate to enable HTTPS. This will encrypt all communication between your devices and recorder.

4. Enable IP Filter:

Enabling your IP filter will prevent everyone, except those with specified IP addresses, from accessing the system.

5. Change ONVIF Password:

On older IP Camera firmware, the ONVIF password does not change when you change the system’s credentials. You will need to either update the camera’s firmware to the latest revision or manually change the ONVIF password.

6. Forward Only Ports You Need:

- Only forward the HTTP and TCP ports that you need to use. Do not forward a huge range of numbers to the device. Do not DMZ the device's IP address.
- You do not need to forward any ports for individual cameras if they are all connected to a recorder on site; just the NVR is needed.

7. Disable Auto-Login on SmartPSS:

Those using SmartPSS to view their system and on a computer that is used by multiple people should disable auto-login. This adds a layer of security to prevent users without the appropriate credentials from accessing the system.

8. Use a Different Username and Password for SmartPSS:

In the event that your social media, bank, email, etc. account is compromised, you would not want someone collecting those passwords and trying them out on your video surveillance system. Using a different username and password for your security system will make it more difficult for someone to guess their way into your system.

9. Limit Features of Guest Accounts:

If your system is set up for multiple users, ensure that each user only has rights to features and functions they need to use to perform their job.

10. UPnP:

- UPnP will automatically try to forward ports in your router or modem. Normally this would be a good thing. However, if your system automatically forwards the ports and you leave the credentials defaulted, you may end up with unwanted visitors.
- If you manually forwarded the HTTP and TCP ports in your router/modem, this feature should be turned off regardless. Disabling UPnP is recommended when the function is not used in real applications.

11. SNMP:

Disable SNMP if you are not using it. If you are using SNMP, you should do so only temporarily, for tracing and testing purposes only.

12. Multicast:

Multicast is used to share video streams between two recorders. Currently there are no known issues involving Multicast, but if you are not using this feature, deactivation can enhance your network security.

13. Check the Log:

If you suspect that someone has gained unauthorized access to your system, you can check the system log. The system log will show you which IP addresses were used to login to your system and what was accessed.

14. Physically Lock Down the Device:

Ideally, you want to prevent any unauthorized physical access to your system. The best way to achieve this is to install the recorder in a lockbox, locking server rack, or in a room that is behind a lock and key.

15. Connect IP Cameras to the PoE Ports on the Back of an NVR:

Cameras connected to the PoE ports on the back of an NVR are isolated from the outside world and cannot be accessed directly.

16. Isolate NVR and IP Camera Network

The network your NVR and IP camera resides on should not be the same network as your public computer network. This will prevent any visitors or unwanted guests from getting access to the same network the security system needs in order to function properly.

Overview

This document elaborates introduction, installation, device adding and FAQ of video doorbell.

Applicable Model







DB10

Operation Definition

| Italic Content | Note |
|---------------------|--|
| <i>Device Name</i> | It represents modifiable parameter name. Specific contents are different depending on settings. Default device name is its serial number and default channel name is channel1. |
| <i>Channel Name</i> | |

Symbol Definition

The following symbols may appear in the document. Please refer to the table below for the respective definition.

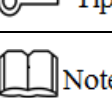
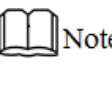
| Symbol | Note |
|---|---|
|  Danger | It indicates a potentially hazardous situation which, if not avoided, could result in death or serious injury. |
|  Warning | It indicates a moderate or low level of potential danger which, if not avoided, could result in minor or moderate injury. |
|  Caution | It indicates a potential risk that, if ignored, could result in damage to device, loss of data, degraded performance, or unpredictable results. |
|  Anti-static | It means electrostatic-sensitive device. |
|  Electric shock protection | It means high-voltage danger. |
|  Laser radiation | It means intensive laser radiation. |
|  Tip | It means that it can help you to solve some problems or save your time. |
|  Note | It means the additional information, which is to emphasize or supplement. |

Revision Record

| No. | Version No. | Revision Content | Release Date |
|-----|-------------|------------------|--------------|
| 1 | V1.0.1 | First release | 2017.9.25 |

Important Safeguards and Warnings

The following description is the correct application method of the device. Please read the manual carefully before use, in order to prevent danger and property loss. Strictly conform to the manual during application and keep it properly after reading.

Operating Requirement

- Please don't place and install the device in an area exposed to direct sunlight or near heat generating device.
- Please don't install the device in a humid, dusty or fuliginous area.
- Please keep its horizontal installation, or install it at stable places, and prevent it from falling.
- Please don't drip or splash liquids onto the device; don't put on the device anything filled with liquids, in order to prevent liquids from flowing into the device.
- Please install the device at well-ventilated places; don't block its ventilation opening.
- Use the device only within rated input and output range.
- Please don't dismantle the device arbitrarily.
- Please transport, use and store the device within allowed humidity and temperature range.

Power Requirement

- The product shall use electric cables (power cables) recommended by this area, which shall be used within its rated specification.
- Please use standard power adapter supplied with this device; otherwise, resulting personal injury or device damage shall be borne by the user.
- Please use power supply that meets SELV (safety extra low voltage) requirements, and supply power with rated voltage that conforms to Limited Power Source in IEC60950-1. For specific power supply requirements, please refer to device labels.
- Products with category I structure shall be connected to grid power output socket, which is equipped with protective grounding.
- Appliance coupler is a disconnecting device; please keep its convenient operation during use.

Table of Contents

| | |
|--|------------|
| Legal Statement | I |
| Cybersecurity Recommendations | II |
| Preface | V |
| Important Safeguards and Warnings | VII |
| 1 Packing List | 1 |
| 2 Device Introduction | 2 |
| 2.1 Front Panel | 2 |
| 2.1.1 Status Description of Indicator Light | 2 |
| 2.1.2 Description of Call Key | 3 |
| 2.2 Rear Panel | 3 |
| 2.2.1 Description of Reset Key | 4 |
| 2.2.2 Description of Wiring Hole | 4 |
| 2.2.3 Description of SD Card Slot..... | 5 |
| 2.2.4 Description of MICRO-USB Charging Port | 5 |
| 2.3 Bottom | 5 |
| 3 Get Started | 6 |
| 3.1 Download APP Client | 6 |
| 3.2 Add Device | 6 |
| 3.3 Doorbell Call | 15 |
| 3.3.1 Online Status of APP | 15 |
| 3.3.2 Closed Status of APP | 17 |
| 3.4 Monitoring | 17 |
| 4 Device Installation | 18 |
| 5 APP Operation | 19 |
| 5.1 Device Management | 19 |
| 5.1.1 Modify Device Info | 19 |
| 5.1.2 Set IR Motion Detection Zone | 20 |
| 5.1.3 Enable Alarm Info..... | 20 |
| 5.1.4 Set Storage Status..... | 21 |
| 5.1.5 Set Cloud Storage Security | 23 |
| 5.1.6 Set Time Zone | 24 |
| 5.1.7 Set Device Share | 25 |
| 5.1.8 Cloud Update | 25 |
| 5.1.9 Modify Wi-Fi Configuration | 26 |
| 5.1.10 Delete Device | 28 |
| 5.2 Settings | 28 |
| 5.2.1 Prompt | 28 |
| 5.2.2 Reset Device Password..... | 29 |
| 5.3 View Info | 29 |
| 5.3.1 APP is Online | 29 |
| 5.3.2 APP is Closed | 32 |

| | |
|---|-----------|
| 5.4 View Local Files | 32 |
| 6 FAQ..... | 34 |
| Appendix 1 Technical Parameters..... | 35 |

1 Packing List

- Check whether device appearance shows obvious damages.
- Check whether all accessories are supplied. Packing list is as follows:
 - ◇ Video doorbell
 - ◇ User's manual
 - ◇ Installation accessories package

2 Device Introduction

2.1 Front Panel

Front panel includes PIR detection, IR light, camera, microphone, indicator light, call key and loudspeaker, as shown in Figure 2-1.

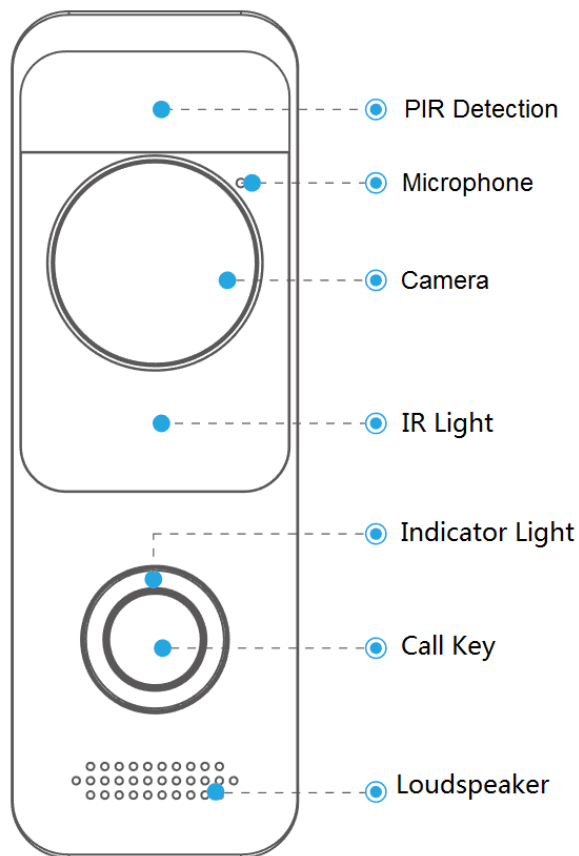



Figure 2-1

2.1.1 Status Description of Indicator Light

Status description of indicator light is shown in Table 2-1.

| Status | Symbol | Description |
|----------------|---|---|
| Green Spinning |  | <ul style="list-style-type: none">• Calling• Enter AP reset mode |
| Green Solid |  | <ul style="list-style-type: none">• Talking• Charging is completed |





| Status | Symbol | Description |
|----------------|---|-----------------------|
| Green Flashing |  | Busy line |
| Red Spinning |  | Charging |
| Red Solid |  | Low electric quantity |
| Red Flashing |  | Abnormal network |

Table 2-1

2.1.2 Description of Call Key

- Press shortly: Call the user;
- For the first time, press it for 5s to enter normal working status.

2.2 Rear Panel

Rear panel includes reset key, wiring hole of chime box, SD card slot and charging port, as shown in Figure 2-2.

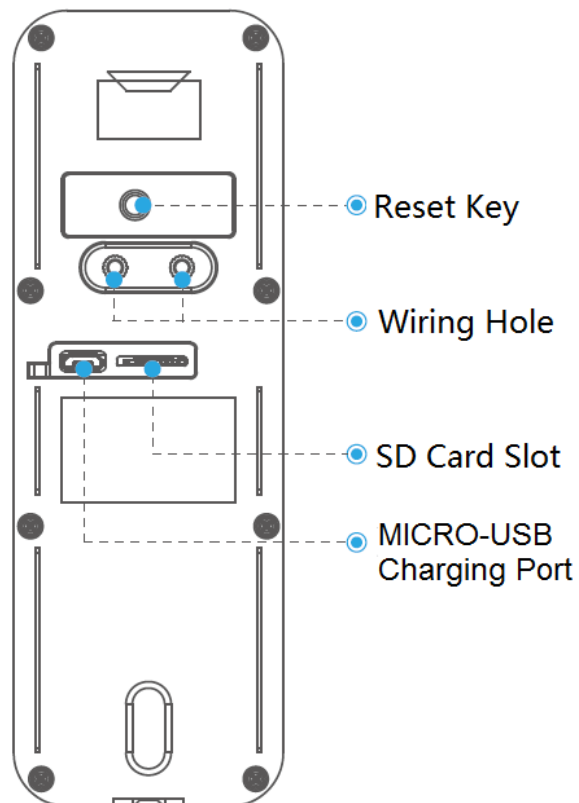

Figure 2-2

2.2.1 Description of Reset Key

- Press it shortly, and indicator light turns to green spinning light, representing that the hotspot has been enabled.
- Press it for 5s, and indicator light is normally on for 3s and then turns off. The device restores factory defaults.

2.2.2 Description of Wiring Hole

As an extended interface, it is used to connect indoor mechanical chime box or electronic chime box.

Connect Mechanical Chime Box

Wiring diagram is shown in Figure 2-3.

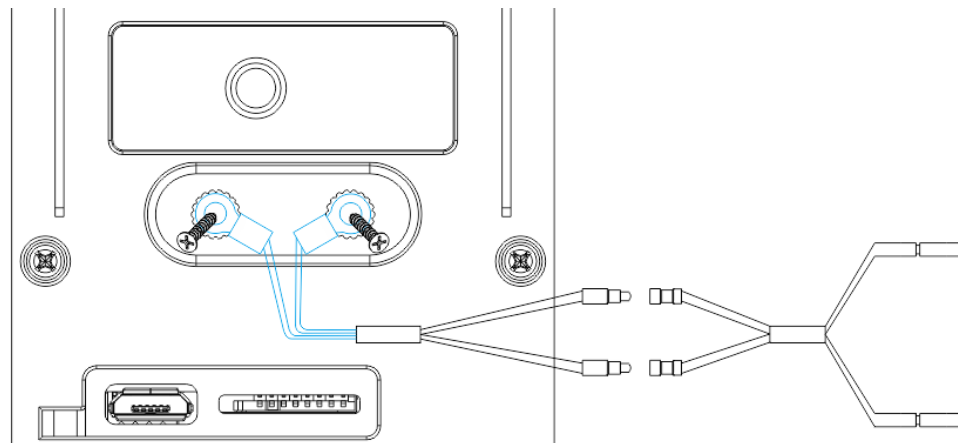

Figure 2-3

Connect Electronic Chime Box

Wiring diagram is shown in Figure 2-4. Diode is used to connect both ends.

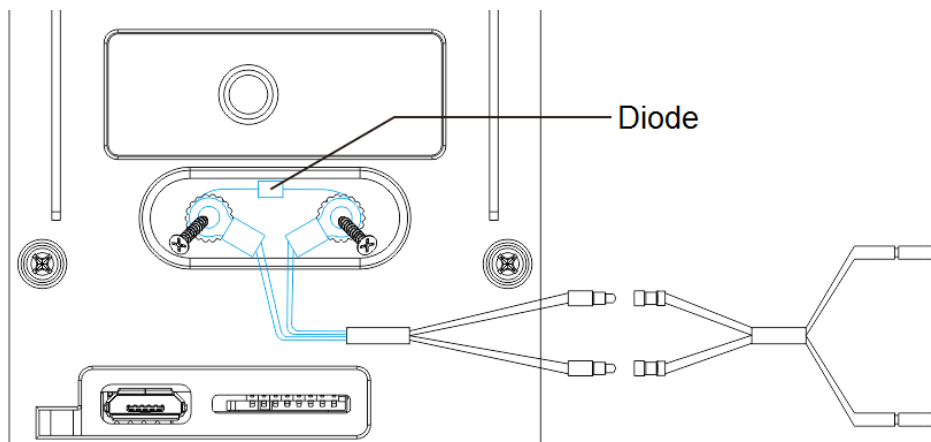

Figure 2-4

2.2.3 Description of SD Card Slot

Insert SD card here, in order to save videos or snapshot.

2.2.4 Description of MICRO-USB Charging Port

When electric quantity of device is lower than 20%, APP in mobile phone will receive a low electric quantity notice. Charge it with MICRO-USB for 3.5 hours (5V, max 2A). Green light will be normally on when charging is completed.

2.3 Bottom

A screw hole at the bottom is used to fix the device onto the bracket, as shown in Figure 2-5.

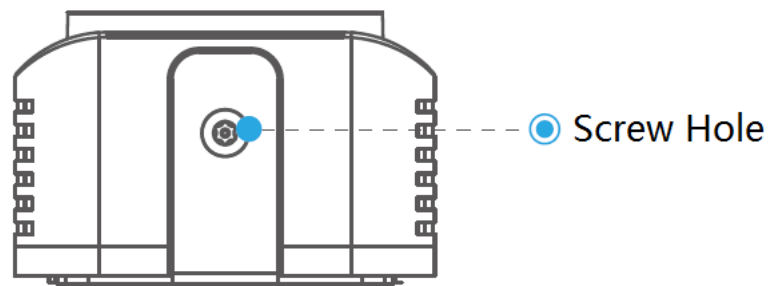

Figure 2-5

Before installation, add the device in APP; ensure that calling and monitoring functions of doorbell and APP work normally. Specific operations are as follows:

3.1 Download APP Client

Please ensure that your mobile phone has connected with Wi-Fi. Scan QR code below, or search “Easy4ip” in APP market, download and log onto APP client. For specific operation, please refer to relevant APP user’s manual.



Figure 3-1



Note

This document takes iOS system as an example and explains operations.

3.2 Add Device



Note

For the first time, press Call Key for 5s to enter normal working status.

- Step 1 At device list interface, press + to enter “QR Code Scanning” interface.
- Step 2 Scan QR code on the device or package; Or press [Input serial number manually], input serial number of the device manually, and press [Next].
The system displays device list interface, as shown in Figure 3-2.

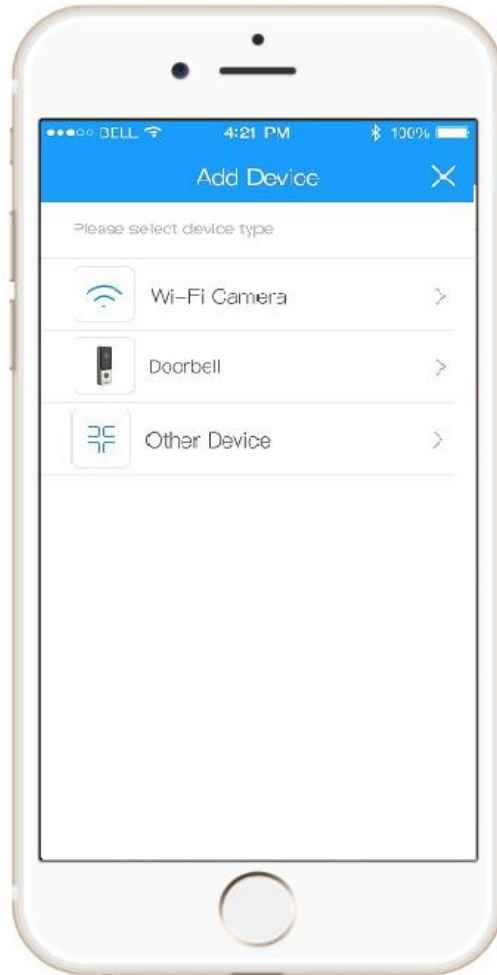

Figure 3-2

Step 3 Choose device type as “Doorbell”. The system displays a prompt interface to enable device hotspot, as shown in Figure 3-3.



Figure 3-3

- Step 4 Press Reset Key on the rear panel of the device. In case of green spinning light, it means that device hotspot is on.
- Step 5 On APP interface, press [Next]. The system displays a prompt interface to connect device hotspot, as shown in Figure 3-4.



Figure 3-4

Step 6 Connect mobile phone Wi-Fi with device hotspot. Hotspot Wi-Fi name is Doorbell-device serial number.

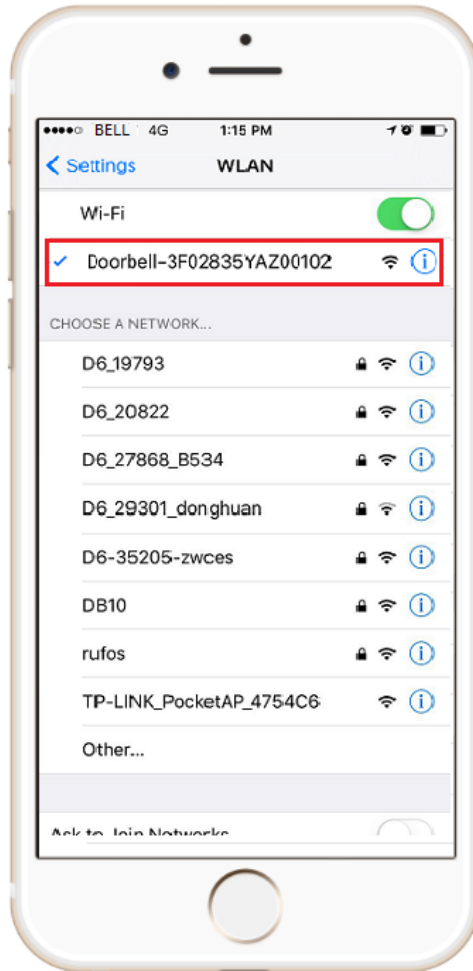

Figure 3-5

Step 7 On APP interface, press [Next].

The system displays device login interface, as shown in Figure 3-6.

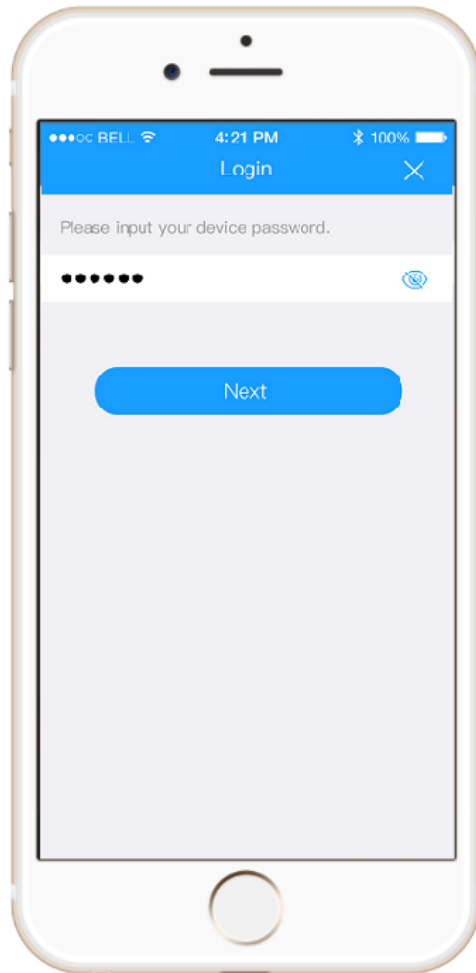

Figure 3-6

- Step 8 Input device password (default password is admin) and press [Next].
The system displays available Wi-Fi list, as shown in Figure 3-7.

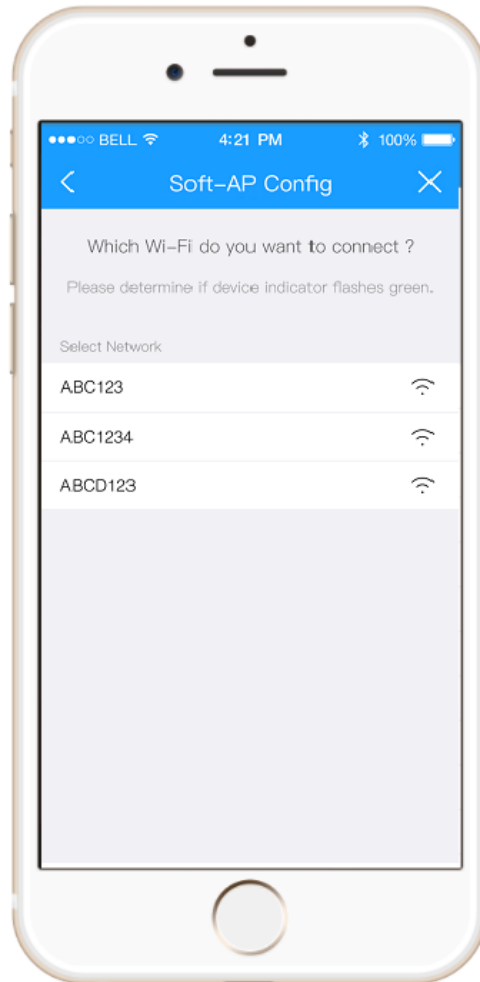

Figure 3-7

Step 9 Choose the Wi-Fi network to be connected.

The system displays Wi-Fi connection interface, as shown in Figure 3-8.

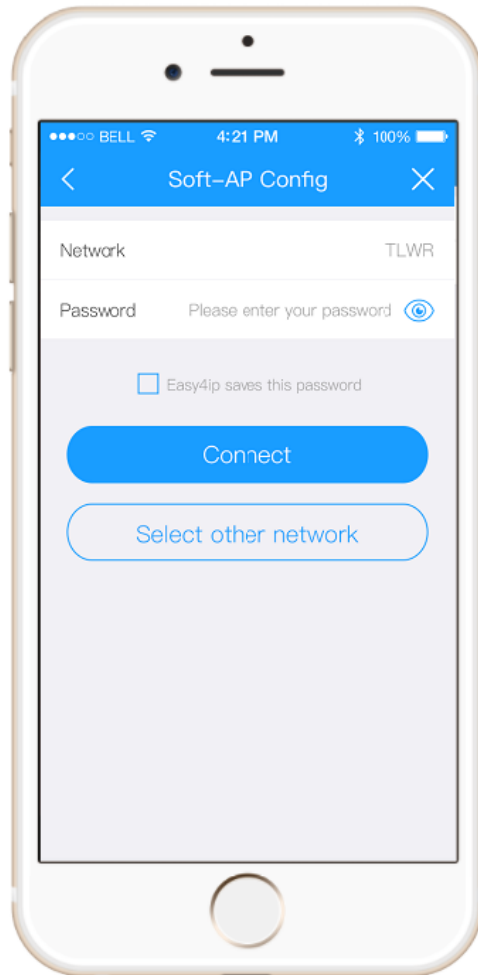

Figure 3-8

Step 10 Input Wi-Fi network password and press [Connect].

The system displays indicator light judgment interface, as shown in Figure 3-9.



Figure 3-9

Step 11 Please determine if device indicator light is green ON and then turns off.

- If green light turns on, it means that the connection is successful.
1. Press [Yes] to add the device to APP. After adding it successfully, display a time zone setting interface, as shown in Figure 3-10.

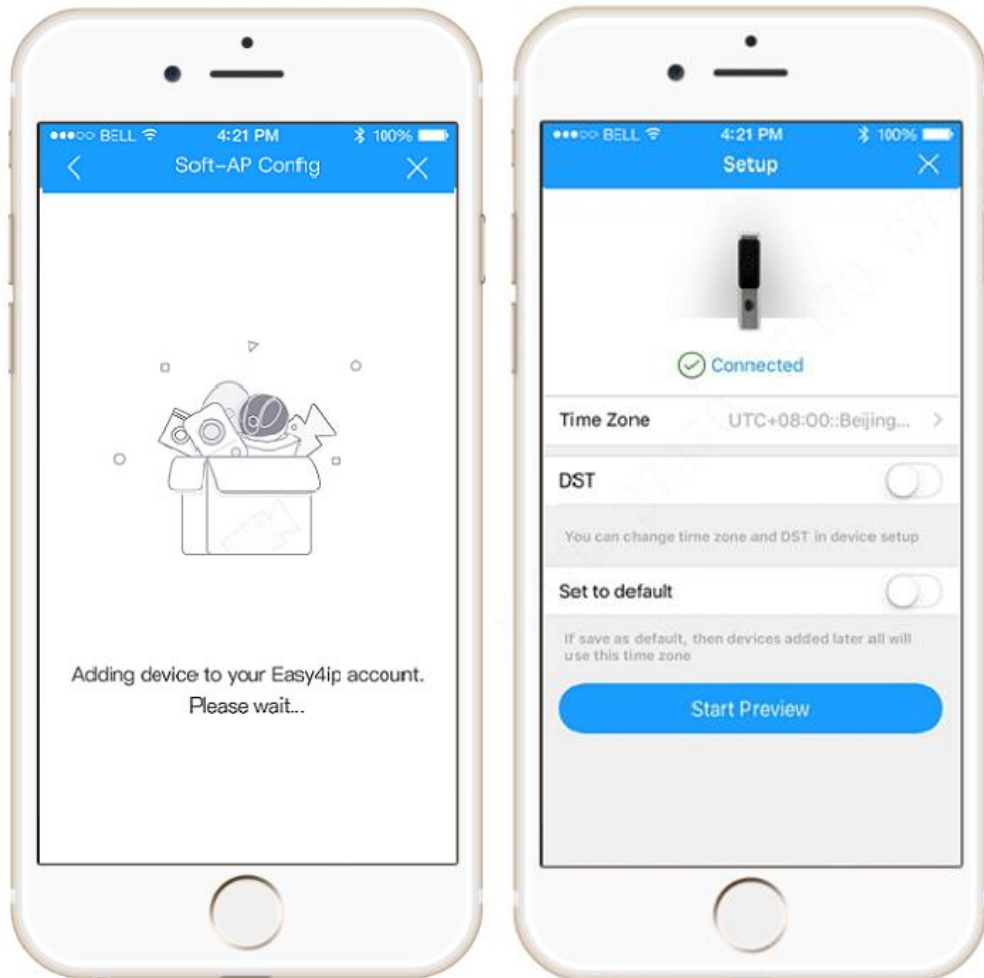

Figure 3-10

2. Set "Time Zone" and "DST".
3. Press [Start Browse] to enter monitoring interface.
 - If the indicator light doesn't turn on, press [Add again], repeat above steps to add it again.

3.3 Doorbell Call

3.3.1 Online Status of APP

Step 1 Press [Call Key] on the doorbell.

In case of green spinning light, APP displays call interface, as shown in Figure 3-11.

 Note

The process from doorbell call to the end of the call will support at most 10 minutes.



Figure 3-11

Step 2 On APP interface, press [Answer] to answer the call. Green indicator light is normally on. For operation of keys on APP interface, please refer to Table 3-1.



Figure 3-12













| Key | Note |
|---|--|
| Mute | It is playing ringtones. Press this key to turn off ringtones, and this key turns to  . Press it again to play ringtones. |
| Accept | It is waiting for you to accept the call. Press this key to accept the call. |
| Hang up | It is waiting for you to accept the call. Press this key to reject the call. |
|  | It is receiving videos at present. Press this key to turn off video, and this key turns to  . Press  again to turn on video. |
|  | It is in voice talking status. Press this key to turn off voice talking, and this key turns to  . Press  again to enable voice talking. |
|  | Present video is standard definition status. Press this key to switch to high definition status, and this key turns to  . Press  again to switch to standard definition status. |
|  | Press this key to get a screenshot of the video, and save the picture in APP local file. |
|  | Press this key to start recording. Recording time is displayed at the upper right corner of the interface. Press it again to stop recording, and save recording file in APP local file. |

Table 3-1

3.3.2 Closed Status of APP

Step 1 Press [Call Key] on the doorbell.

In case of green spinning light, mobile phone will receive a call notice, as shown in Figure 3-13.

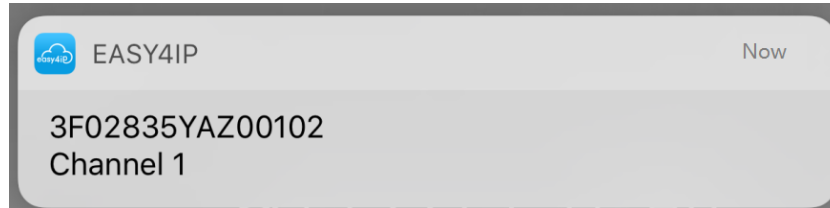

Figure 3-13

Step 2 According to prompt of this notice, enter doorbell monitoring interface, realize monitoring and voice talking function.

3.4 Monitoring

Press a picture under a serial number in the device list, and open doorbell monitoring interface, as shown in Figure 3-14. Press any position in the interface, and operation keys will be displayed. Please refer to Table 3-1 for details.



Figure 3-14

4 Device Installation



Caution

Before installation, please ensure that the device has been added. Please refer to “3.2 Add Device” for details.

- Step 1 Loosen M3×6 screws at the bottom of the device, and dismantle the installation bracket from the device.
- Step 2 Drill holes in the wall according to hole positions of installation bracket, and install plastic expansion pipes.
- Step 3 Fix the bracket onto the wall with three ST3×20 self-tapping screws.



Note

To connect a chime box, please connect cables before fixing the bracket, and lead them out of the bracket.

- Step 4 Put the device into the slot at the top of the bracket from top to bottom.
- Step 5 Fix the device onto the bracket with M3×6 screws.

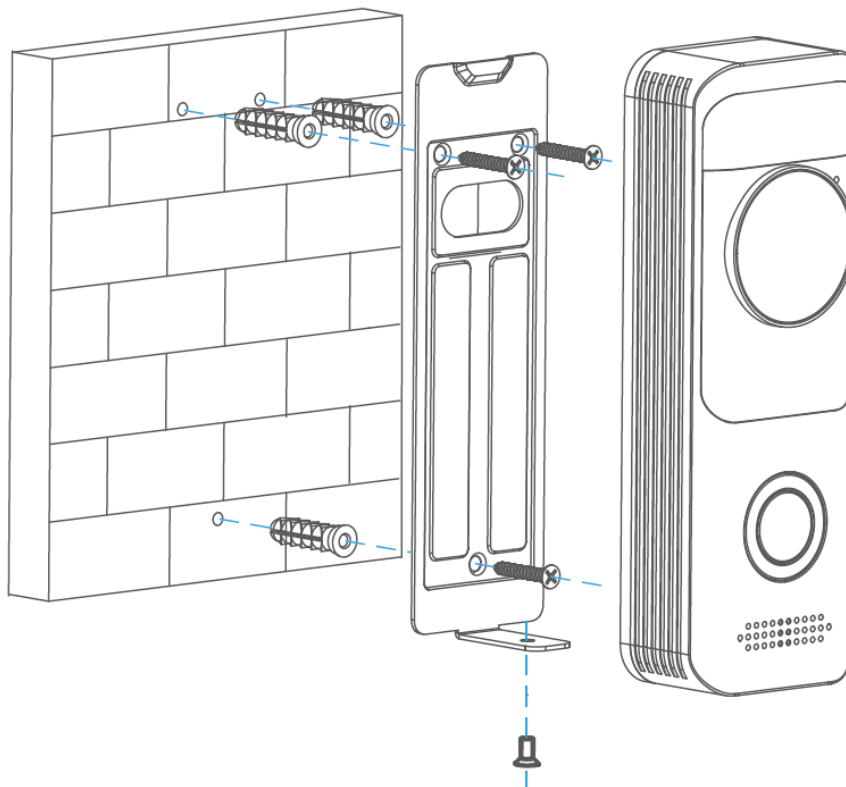

Figure 4-1

5.1 Device Management

5.1.1 Modify Device Info

Modify device photo, device name and channel name; view its SN.

Step 1 Select “Me> My Device > Device Name > Device Name”.

The system displays “Device Info” interface, as shown in Figure 5-1.

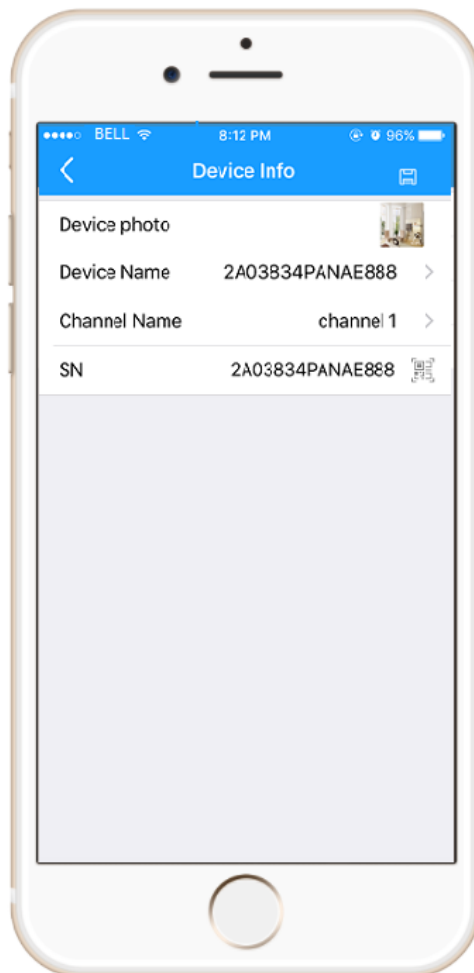



Figure 5-1

Step 2 Modify the parameters according to needs.

Step 3 Press  to save the settings.

 Note

By default, “Device Name” is its SN.

5.1.2 Set IR Motion Detection Zone

After setting IR motion detection zone, a motion detection alarm will be sent if an object moves in the zone.

Step 1 Select “Me> My Device > Device Name > Motion Detection Zone”.

The system displays zone setting interface, as shown in Figure 5-2.



Figure 5-2

Step 2 Set IR motion detection zone and distance.

- Press zone block to enable or disable IR motion detection of this zone.
- Slide the dot in the left; adjust far/near detection distance of the zone.

 Note

Detection range of the device is horizontal 140°, which is divided into 5 zones. IR motion detection is enabled in all zones by default.

Step 3 Press [Save] to save the settings.

5.1.3 Enable Alarm Info

After it is enabled, low battery prompt and IR motion detection alarm will be sent to APP.

Step 1 Select “Me> My Device > Device Name > Alarm”.

The system displays “Alarm” interface, as shown in Figure 5-3.

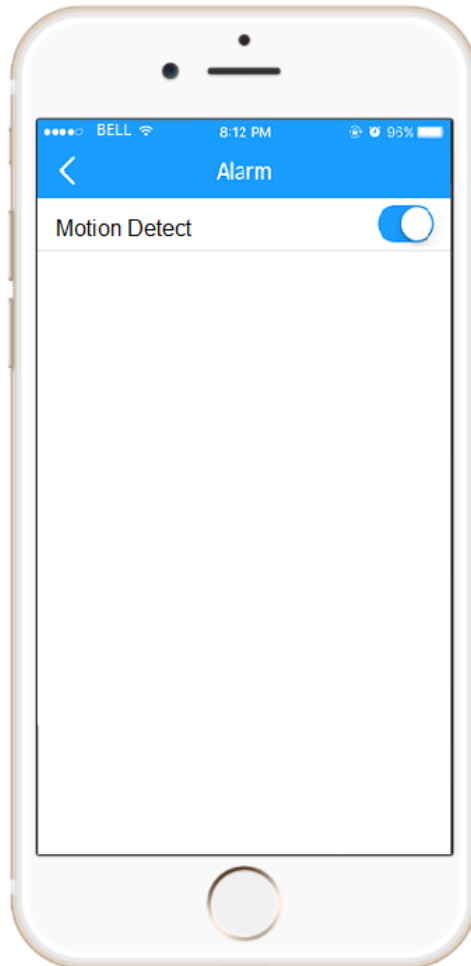

Figure 5-3

Step 2 Press  .

Enable it to send info to APP. The key turns to  .

5.1.4 Set Storage Status

Enable or disable recording and picture storage function.

- If cloud storage is enabled, recording or pictures will be stored at cloud server.
- If cloud storage is not enabled and SD card is inserted into the device, recording or pictures will be stored in SD card.

 Note

It is suggested that cloud storage function should be enabled.

5.1.4.1 Cloud Storage

Easy4ip comes with a one-month free trial of cloud storage, one channel for one account. After enabling this function, pictures or recording files will be stored at cloud server automatically.

Select “Me> My Device > Device Name >Storage Status > Cloud Storage > Channel Name”; select the item to buy it.



Note

- One APP account enables trial function for only one device.
- It is suggested that cloud storage function should be enabled.

5.1.4.2 SD Card Storage

If cloud storage is not enabled, insert SD card, so recording or pictures will be stored in SD card automatically.

Select “Me> My Device > Device Name >Storage Status”, as shown in Figure 5-4.

- Press [Device Storage] to view the capacity utilization status of SD card.
- Press [Format Storage Device] to format the SD card.

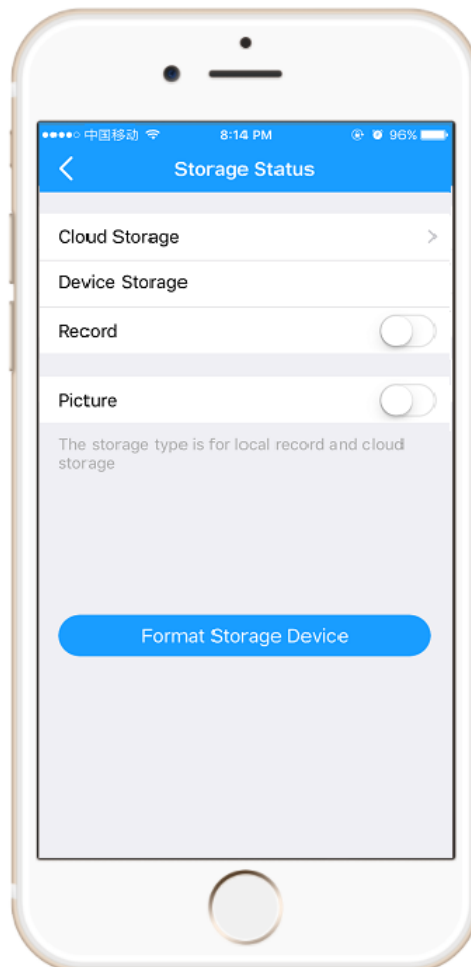



Figure 5-4

5.1.4.3 Enable Record/Picture Storage

Step 1 Select “Me> My Device > Device Name >Storage Status”.
The system displays “Storage Status” interface.

Step 2 Press  to enable record storage or picture storage.

If record storage is enabled, select the maximum time length of every recording, including 15s, 30s and 45s, as shown in Figure 5-5.



- Record storage and picture storage cannot be enabled simultaneously. When one storage mode is enabled, the other one will be disabled automatically.
- If cloud storage is not in place or SD card is not inserted, it will be invalid to enable the functions.



Figure 5-5

5.1.5 Set Cloud Storage Security

After enabling cloud storage function, modify cloud storage security password. The default password is device SN.

Step 1 Select “Me> My Device > Device Name >Cloud Storage Security >Cloud Storage Password”.

The system displays “Cloud Storage Security” interface, as shown in Figure 5-6.

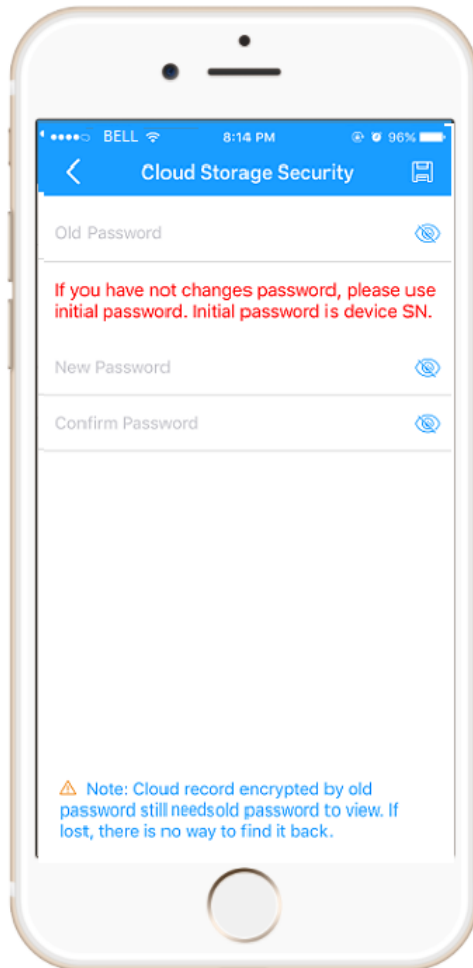

Figure 5-6

Step 2 Input “Old Password”, “New Password” and “Confirm Password”.

Step 3 Press  to save the settings.

 Note

When record or picture files are stored on cloud server, the system encrypts the files with current cloud storage security password automatically. To view the files, the encrypted cloud storage security password at the time shall be entered too.

5.1.6 Set Time Zone

Set local time zone and DST, ensure snapshot and recording time points are consistent with local time points, so as to search and view conveniently.

Step 1 Select “Me> My Device > Device Name > Time Zone”.

The system displays “Time Zone” interface, as shown in Figure 5-7.

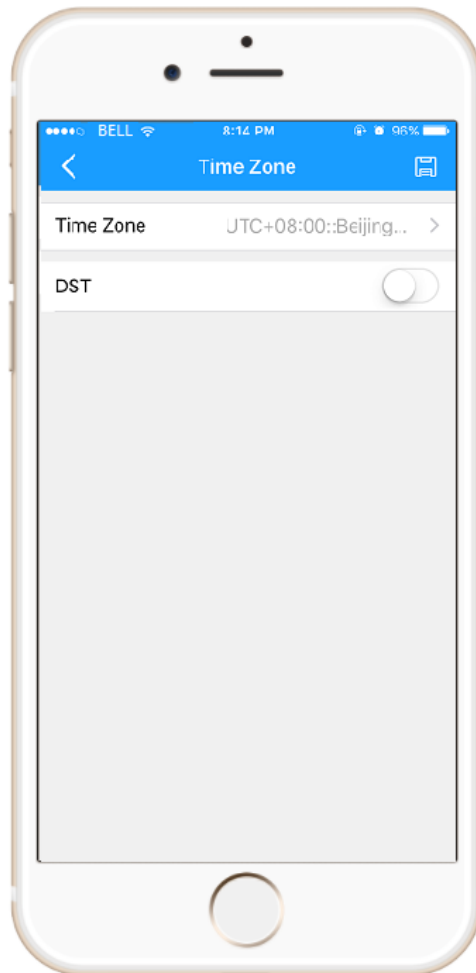



Figure 5-7

Step 2 Press “Time Zone” to select local time zone.

Step 3 (Optional) press  to enable DST; set “Start Time” and “End Time”.

Step 4 Press  to save settings.

5.1.7 Set Device Share

This function is not available at present.

5.1.8 Cloud Update

After entering the update interface, update the device to the latest version.

Step 1 Select “Me> My Device > Device Name > Update”.

The system displays “Update” interface, as shown in Figure 5-8.

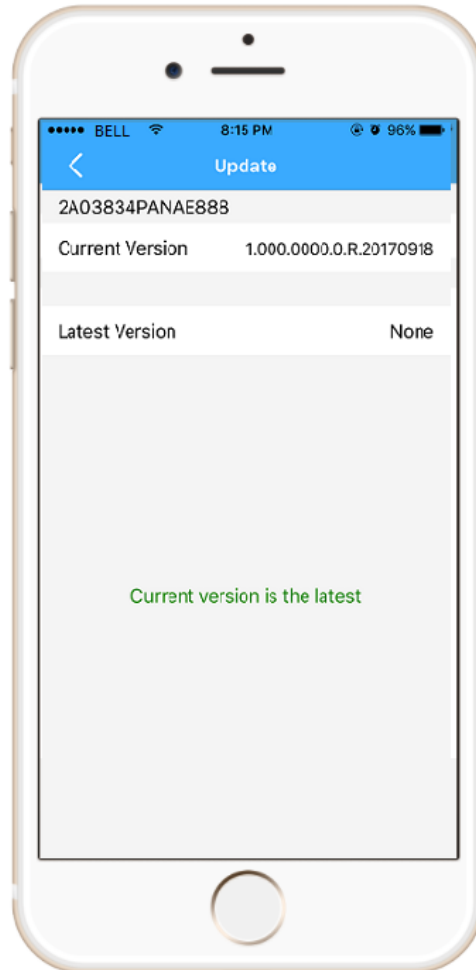

Figure 5-8

Step 2 Press [Start Update]. Update the device according to interface prompt. The device reboots automatically after successful update.

5.1.9 Modify Wi-Fi Configuration

Modify Wi-Fi configuration of the device, in order to connect with other Wi-Fi networks.

Step 1 Select "Me> My Device > Device Name > Wi-Fi Config".

The system displays "Wi-Fi Config" interface, as shown in Figure 5-9.

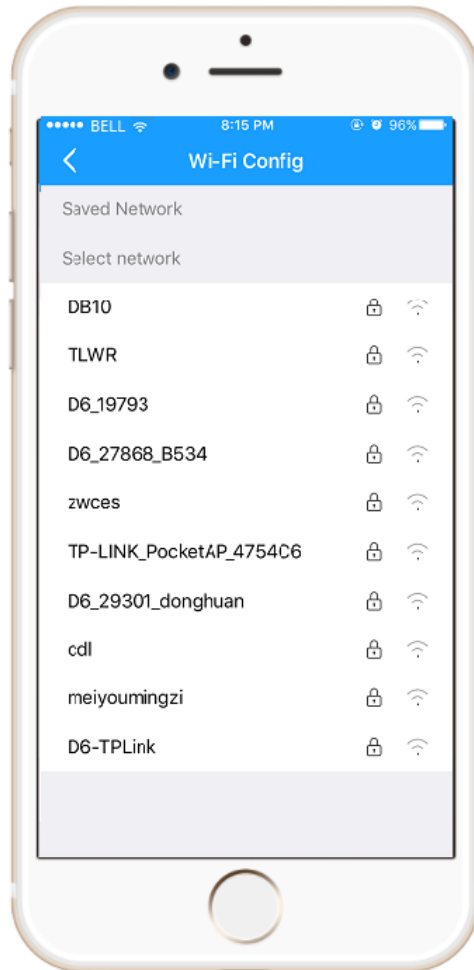

Figure 5-9

Step 2 Select new Wi-Fi and enter the password.

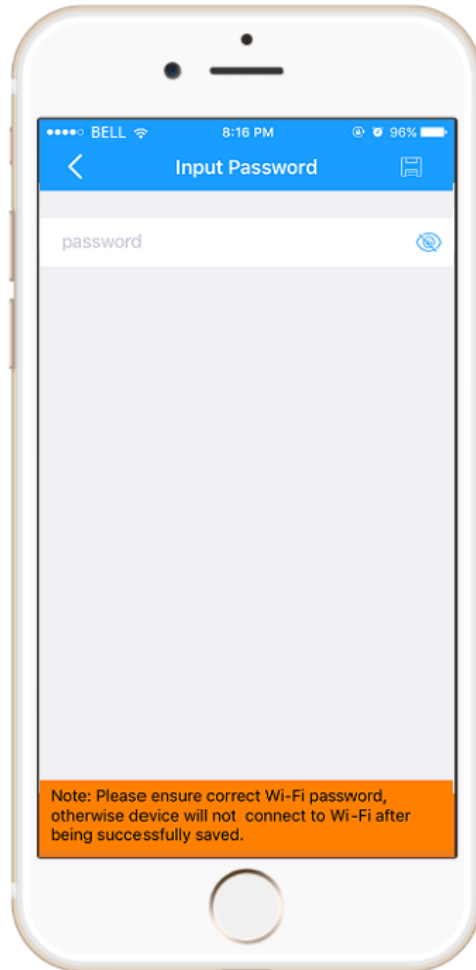

Figure 5-10

Step 3 Press  to connect new Wi-Fi network.

5.1.10 Delete Device

Select “Me> My Device > Device Name > Delete Device”, so as to unbind the device.

5.2 Settings

5.2.1 Prompt

After prompt function is enabled, be able to receive prompts when APP is closed, such as call not answered, passive infrared and low battery.

Step 1 Select “Me> Settings”.

The system displays “Settings” interface, as shown in Figure 5-11.

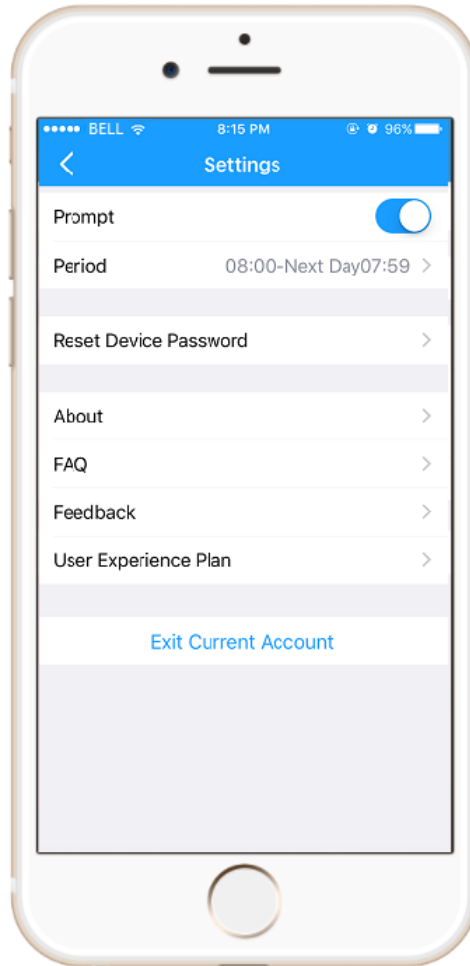



Figure 5-11

Step 2 Press  to enable prompt function.

Step 3 Press [Period] to set “Start Time” and “End Time”.

5.2.2 Reset Device Password

This function is not available at present.

5.3 View Info

5.3.1 APP is Online

View alarm info in the recent 7 days, such as passive infrared, low battery and call not answered.

When APP is online, select “Info > Alarm Info> Device Name”, as shown in Figure 5-12. Red dot means that this info is not read yet.

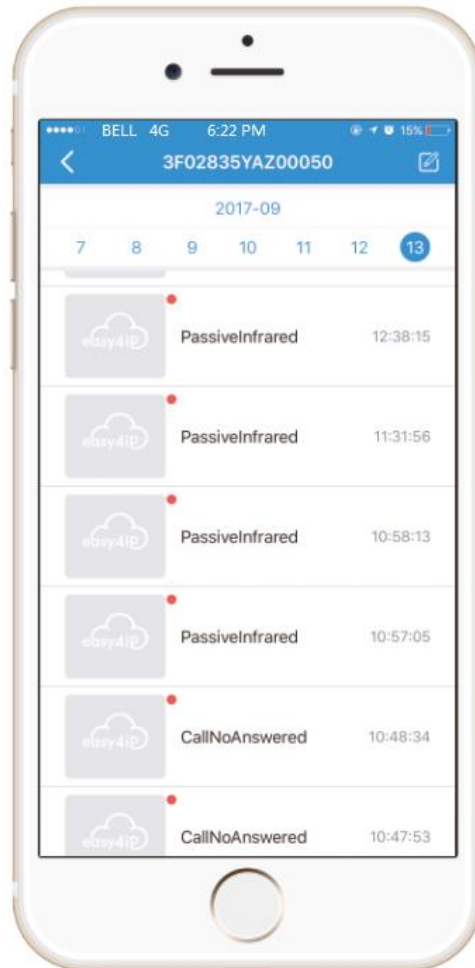

Figure 5-12

If cloud storage is enabled or SD card is inserted, video storage or snapshot storage is enabled, videos and snapshots can be viewed when passive infrared alarm prompt or call not answered prompt is selected, as shown in Figure 5-13 and Figure 5-14.

- Press [LIVE] to monitor doorbell image. Please refer to “3.4 Monitoring” for monitoring interface operation.
- Press [Return] to exit.

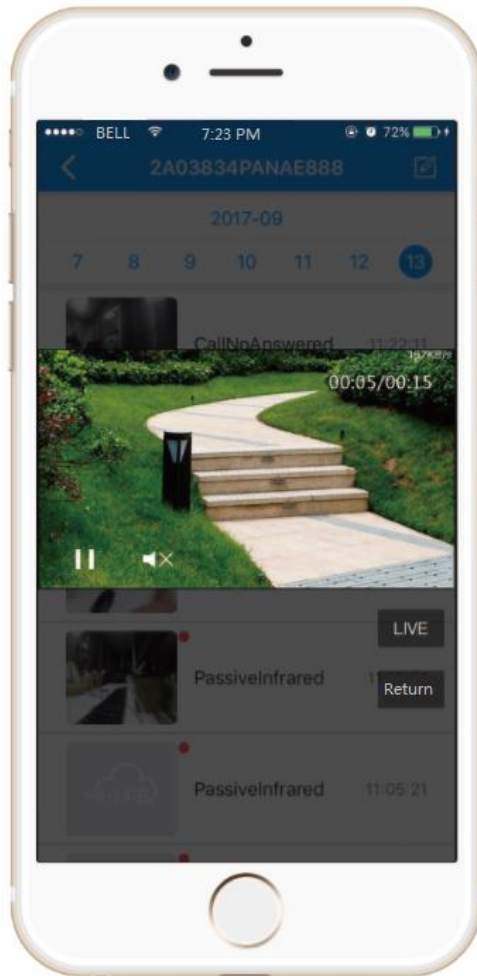

Figure 5-13

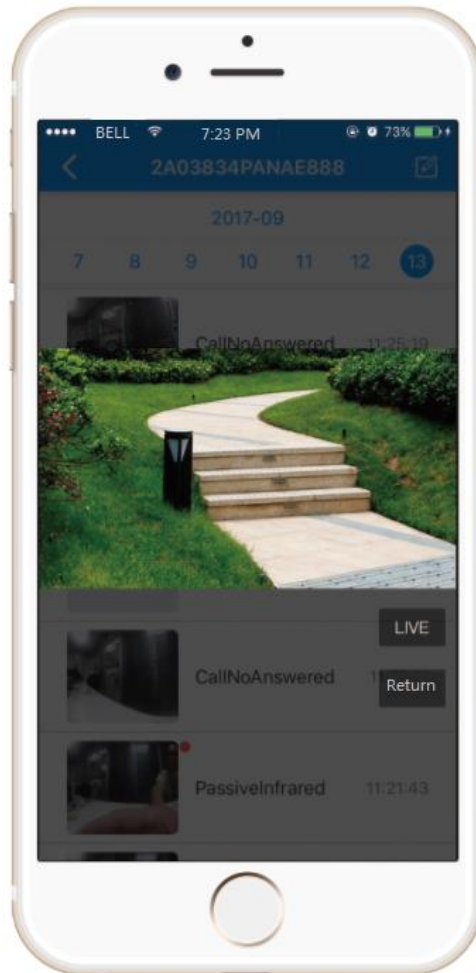

Figure 5-14

5.3.2 APP is Closed

In case of passive infrared, low battery and call not answered alarms when APP is closed, notify in the form of prompts, as shown in Figure 5-15.

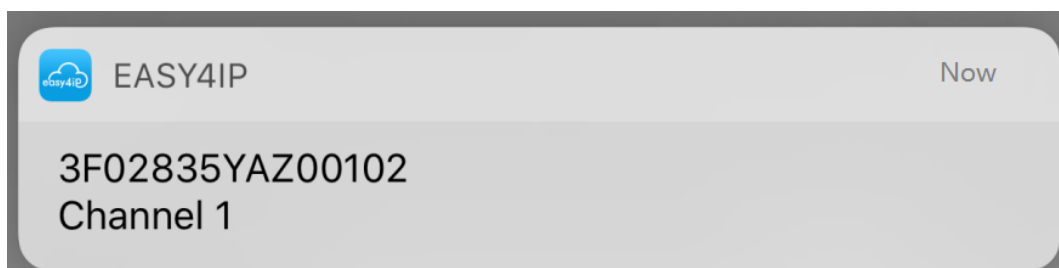



Figure 5-15

In case of passive infrared or call not answered prompt, press this prompt to view videos and snapshots.

5.4 View Local Files

View snapshots and videos.

Select “Me >Local File”, as shown in Figure 5-16.

- Press , switch to interface of picture list, select a picture and zoom in to view its content.
- Press , switch to interface of video list, select a video and play back the video.

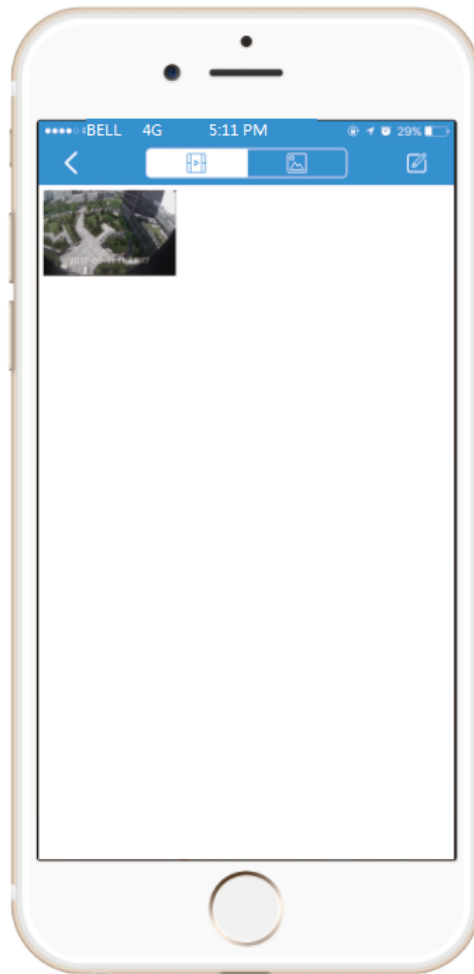

Figure 5-16

Question 1

Q: How to restore factory settings?

A: Please press Reset Key on the rear panel of the device for 5s. After completion, green light will be on for 3s and then turn off; the device will reboot automatically.

Question 2

Q: The device cannot work normally?

A: Please restore factory default settings, and configure the device again.

Question 3

Q: How to enter wireless configuration mode?

A: Please press Reset Key on the rear panel of the device shortly, until the indicator light turns to be green spinning light, it means that hotspot has been enabled.

Question 4

Q: The device is not online?

A: Please check the state of device indicator light. If red light flickers all the time, it means that the device fails to connect the network. Please check whether wireless router can connect the network; connect your mobile phone with this wireless network, in order to test it. If it can connect the network, please configure the device again.

Question 5

Q: Hotspot connection is overtime?

A: a. The device, mobile phone and router are too far away. Please ensure that the distance is within 10cm.

b. The device starts configuration without reminder of waiting to connect the network.

Question 6

Q: The device doesn't respond?

A: Please confirm electric quantity of the device. In case of low electric quantity, please charge.

Appendix 1 Technical Parameters

| Parameter | Note |
|-----------------------|--|
| Power Supply | Working power is supplied by battery. Charging power of battery is DC 5V/2A. |
| Power Consumption | Max. 2.5W and min. 2mW |
| Dimension | 148mm×50mm×29mm |
| Weight | 0.6g |
| Operating Temperature | -20℃～+60℃ |
| Charging Temperature | 0℃～+40℃ |
| Operating Humidity | 10%～90% |

Appendix Table 1-1